

		REVISIONS			
ZONE	REV.	DESCRIPTION		DATE	APPROVED

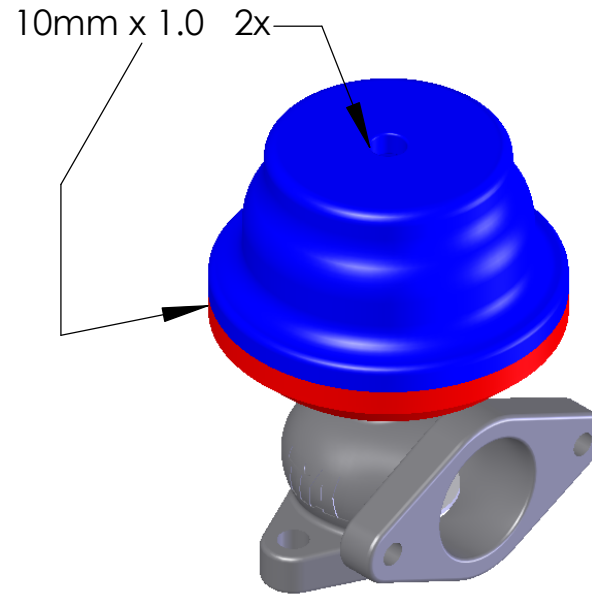
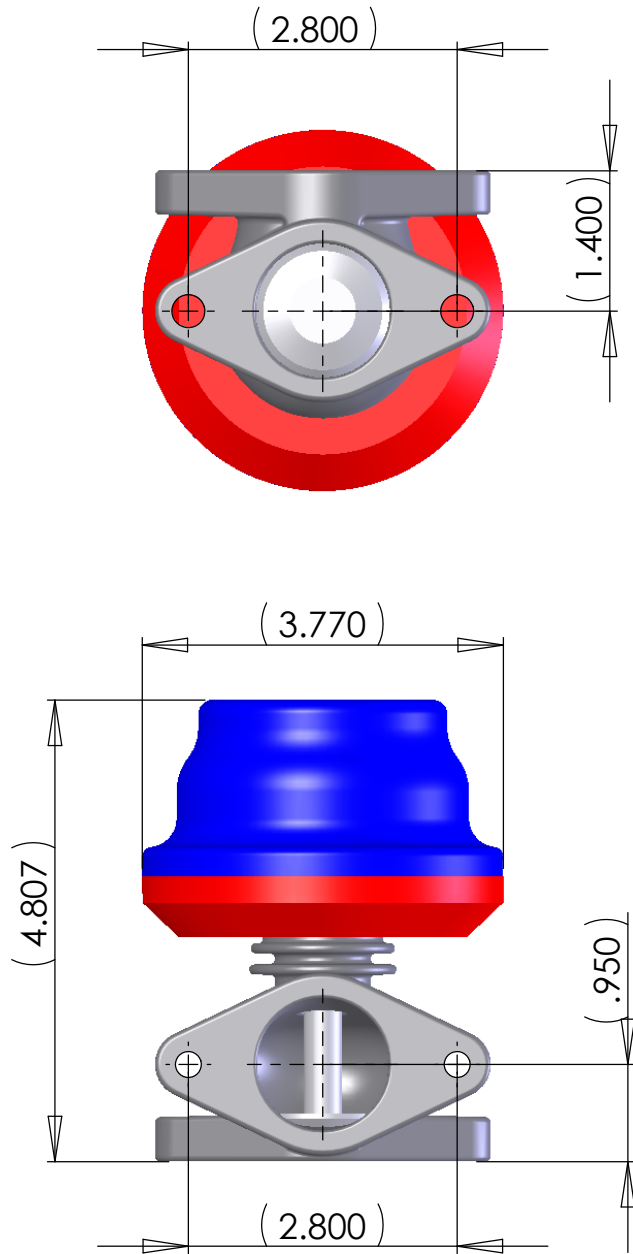

PROPRIETARY AND CONFIDENTIAL
 THE INFORMATION CONTAINED IN THIS DRAWING IS THE SOLE PROPERTY OF TiAL Products. ANY REPRODUCTION IN PART OR AS A WHOLE WITHOUT THE WRITTEN PERMISSION OF TiAL Products IS PROHIBITED.

		DIMENSIONS ARE IN INCHES TOLERANCES: FRACTIONAL ± ANGULAR: MACH ± BEND ± TWO PLACE DECIMAL ± THREE PLACE DECIMAL ±	NAME	DATE	TiAL Products	
			DRAWN			
			CHECKED		WG 38 mm	
			ENG APPR.			
			MFG APPR.			
		MATERIAL	Q.A.		SIZE	DWG. NO.
		FINISH	COMMENTS:		A	
NEXT ASSY	USED ON				SCALE:1:1	WEIGHT:
APPLICATION	DO NOT SCALE DRAWING					SHEET 1 OF 1