

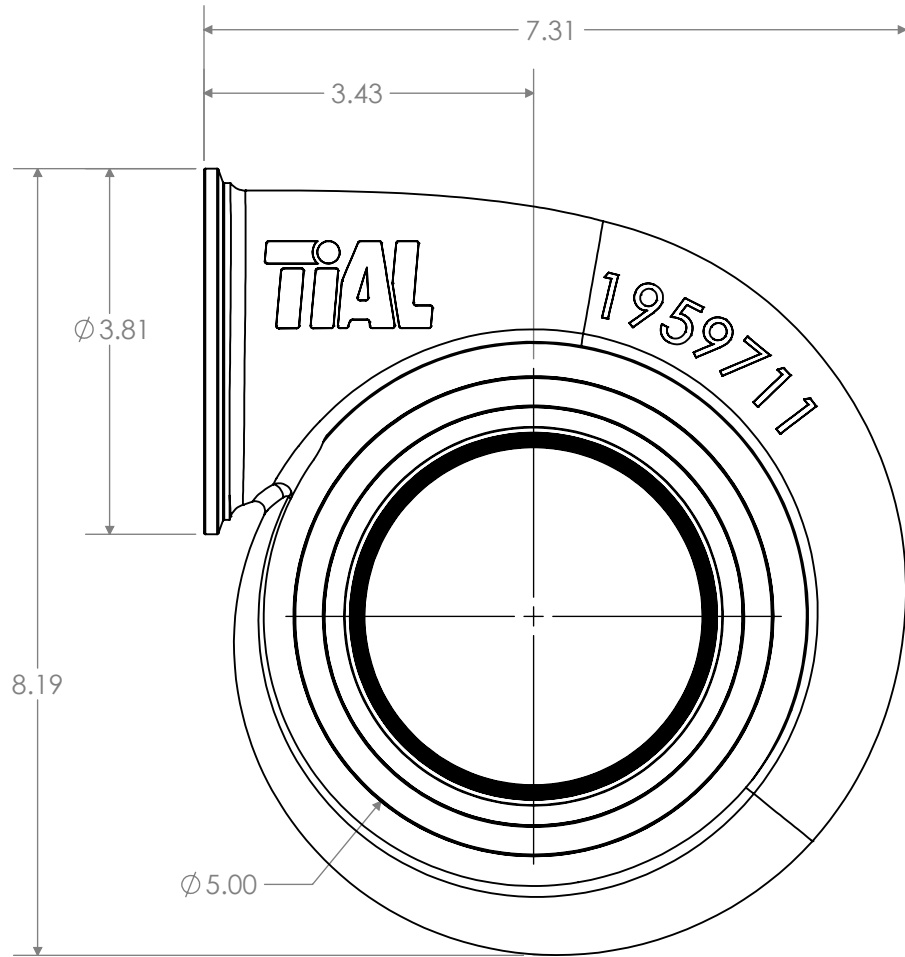

REVISIONS			
REV	DATE	DESCRIPTION	DWN
A	6/27/18	RELEASED	AJE
-	-	-	-
-	-	-	-

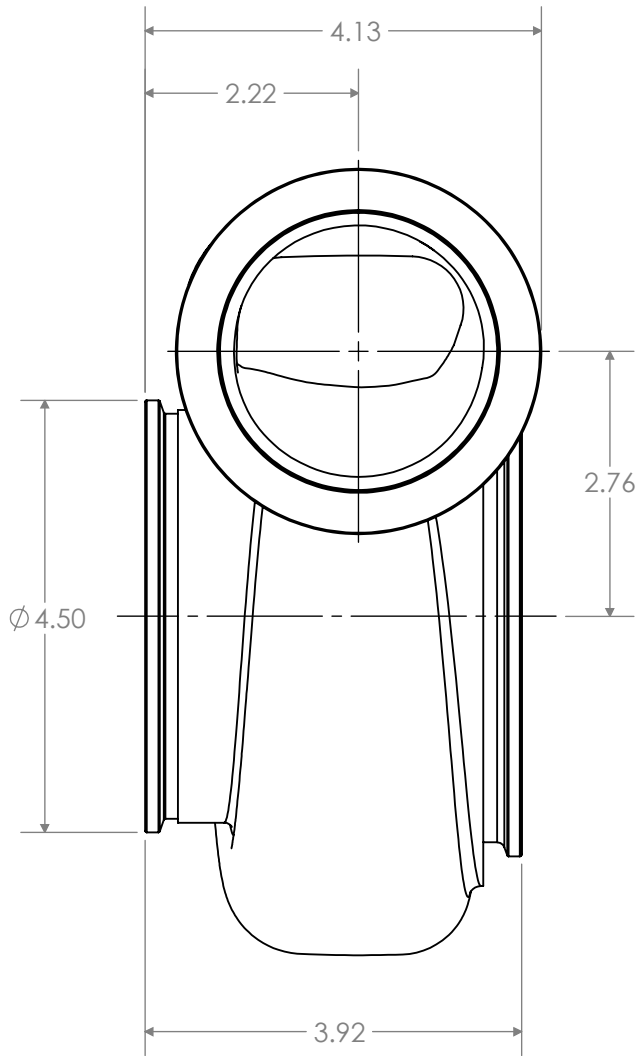
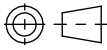

		TIAL PRODUCTS 450 S. SHIAWASSEE OWOSSO, MI 48867			
UNLESS OTHERWISE SPECIFIED: DIMENSIONS ARE IN INCHES ANGULAR DIMENSIONS ARE IN DEGREES		PART DESCRIPTION TIALVB BWS400 117AR 95MM PUBLIC			
DO NOT SCALE DRAWING		OP#		TYPE	
SIZE A		PART NO.		REV A	
MATERIAL		DRAWN BY: AJE	DATE DRAWN: 6/27/18	CHECKED BY: XXX	DATE CHECKED: 12/17/15
				SHEET: 1 OF 1	

PROPRIETARY AND CONFIDENTIAL
 THE INFORMATION CONTAINED IN THIS DRAWING IS THE SOLE PROPERTY OF TIAL PRODUCTS. ANY REPRODUCTION IN PART OR AS A WHOLE WITHOUT THE WRITTEN PERMISSION OF TIAL PRODUCTS IS STRICTLY PROHIBITED.